

THESE INSTALLATION INSTRUCTIONS ARE FOR THE LAMINATE UNICLIC LOCKING SYSTEM ONLY.



ATTENTION! READ BEFORE INSTALLING! INSTALLER – HOMEOWNER RESPONSIBILITY

This product may have very high color/character variation. Work out of several cartons simultaneously during installation. When finished moldings are required for the project, pre-select the plank(s) that best coordinates with the color of the adjacent molding piece(s). A minimum 6 mill poly film moisture retarder is required over all substrates (concrete, tile, and vinyl) and underneath the laminate plank flooring. Once the floor is installed it is deemed acceptable. Please make sure that the homeowner is present during installation. We will not cover any labor or material if the floor needs to be taken up. Our flooring does have attached padding if you want to place another padding we require you to test the additional padding with the Underlayments company. The warranty will need to be covered by them for any structural complaints - profile, gapping, squeaking noise, bevel chipping and excess vertical movement.

FOR BEST VISUAL REPRESENTATION OF YOUR FLOOR

This flooring replicates the look of a natural product which has natural variations in color and texture. For best visual effect, shuffle planks from several cartons and do not install similar boards next to one another.

COLOR VARIATION

Batch to Batch – inspect the carton label production run of flooring you received and make sure it meets your expectations. Layout several cartons of material to confirm lots can be mixed.

FINISH

Is the gloss correct? Does the look of the finish meet the owner's expectations? Does the owner understand that the finish will scratch, and wear and that care must be taken during the installation, move-in and in-use?

If you answered yes then you have now made sure that the owner will not be disappointed once the flooring is installed and they see it for the first time! The person installing the floor is responsible for visual issues once the flooring is installed. Avoid excessive heat and light exposure which can cause degradation of the product.

SUBFLOOR PREPARATION

Subfloor should be dry and level to 3/16" per 10 ft. radius for best installation results. Laminate flooring should only be used indoors.

ENGAGING END JOINT

When engaging end-joints a tapping block is required please refer to the instructions on page 5. Open joints of .04 inches (1mm) are not considered a defect under the joint integrity warranty.

NOISE COMPLAINTS

After completion of the project check to see if the flooring is not squeaking. If the flooring is squeaking that means the subfloor has issues of movement or not flat within the required tolerances. Pull up the flooring in those areas and address the issues with the subfloor before closing off the project.

FLOORING MATERIAL SHOULD BE INSPECTED PRIOR TO INSTALLATION

Responsibility for the suitability of Manufacturer flooring and accompanying products for each individual installation cannot be assumed by Manufacturer, since Manufacturer has no control over the installer's proper application. Sample Boards may not always match the flooring due to light conditions and change of color due to oxidizing therefore, the homeowner should always be present when the installation takes place. Should an individual plank or tile be doubtful as to appearance or dimension the installer should not use this piece. Once a plank is installed it is deemed acceptable by a Homeowner/Installer. Always inspect material from different angles, any visual imperfection is part of the realistic wood look decor style.

NOTE: Manufacturer flooring with attached underlayment CANNOT be installed with a glue-down method. Keep a Permanent Job Record and provide a copy to the owner. Request this from your local distributor.

DO NOT INSTALL ANY DEFECTIVE PLANKS

If you do or don't see any defects during the installation, it is the responsibility of installer/homeowner to cull them out. Manufacturer will

not be responsible for any additional labor, additional floor or any other potential cost. We always advise the homeowner to purchase 10% extra for waste. It is important and require the homeowner to stock 10% of additional stock for future repairs. If the homeowner does not, then the manufacturer/distributor will not be responsible if your floors are discontinued.

READ BEFORE INSTALLING

Flooring is not a moisture barrier. Concrete should always be cured and tested for moisture and a moisture barrier should always be installed in the crawl space and even under the floor over a concrete sub-floor. Please refer below for further guidance. Please check for defects, squeaky noises, sub-floor issue or finish issues by installing 100 sq. ft. of flooring. Because houses and buildings, as well as adjacent hardwood or laminate floors, expand and contract, Manufacturer recommends leaving an expansion gap the thickness of the plank between the perimeter walls, door frame/entrances and any adjacent floor. Do not install floors where it will be exposed to temperatures greater than 85° F. Use good common-sense installation practices, and you'll have a successful installation that results in a beautiful floor. Check that all ITEM NUMBERS are the same and that you have purchased sufficient packs to complete the job. Floor exposed to low and high moisture at any time during or after installation may cause the floors to cup, lift, peak or separate. During any inspection the inspector may not find moisture at the present time but because of the structure movement of the planks, moisture or a jobsite condition might change the floor.

KEYS TO SUCCESSFUL LOCKING INSTALLATION

All planks should be checked before and during installation for faults which are clearly visible; this will reduce problems when assembling and identify any color differences. The inspection should be performed in daylight, or under good artificial lighting, in the room in which the products are to be installed. If flooring is not acceptable, contact your supplier immediately and arrange for replacement. Manufacturer cannot accept responsibility for flooring installed with visible defects. Prior to installation of any flooring, the installer must ensure that the job-site and sub-floor meet the requirements of these instructions. Manufacturer is not responsible for flooring failure resulting from unsatisfactory job-site and/or sub-floor conditions. Flooring should be one of the last items installed in any new construction or remodel project. If you don't engage the locking system correctly or cause a fracture on the locking system that is unseen during installation, the lock system will break/separate over time and the planks will come apart. It is the responsibility of the installer to ensure the engage the planks correctly without causing any fracture to the locking system.

CRAWL SPACES

Crawl spaces must be a minimum of 18" (46 cm) from the ground to the underside of the joists. A ground cover of 6–20 mil black polyethylene film is required as a vapor barrier with joints lapped 6" (15 cm) and sealed with moisture resistant tape. The crawl space should have perimeter venting equal to a minimum of 1.5% of the crawl space square footage. These vents should be properly located to foster cross ventilation. Local regulations prevail where necessary.

WASTE

Most installations will need approximately a 10% cutting and waste allowance added to the square footage of the room.

TEMPERATURE & HUMIDITY

Room temperature and humidity of installation area should be consistent with normal, year-round living conditions for at least one week before installation of flooring. Maintaining an optimum room temperature of 70° F and a humidity range of 40-55% is recommended throughout the space.

STORING

Proper conditioning of the job site is necessary. Flooring planks should not be exposed to sudden changes in temperature. Store, transport and handle the flooring planks in a manner to prevent any distortions. Distortions will not disappear over time. Store cartons flat, never on edge. Insure that the flooring planks are lying flat at time of installation.

TRANSITIONS

When installing next to other types of flooring use a transitions strip/molding. Installations of carpet, tiles, metal strips and other transition moldings should not push fully into the flooring and should allow for some slight movement wherever practical.

ROOMS LONGER THAN 55'

For rooms, wider or longer than 55', the use of T-moldings is required to account for the normal movement or seasonal expansion/contraction of the floor. If the homeowner does experience gapping then we would suggest the contractor tap the planks back together since they may come apart for longer run lengths. Protect the floor from heavy-rolling loads, other trades, and movement of appliances by using sheets of plywood or similar. The following condition must be met for the floor to perform properly if a transition is not used up to a 55' long run. For these areas the perimeter needs to double the thickness of the plank. If you don't following the environmental conditions all year round then you will experience gapping in the end joints which is not manufacturing related:

1. Temperature: 55-85% or an average temperature of 70%
2. Humidity should be keep with the 40-50% humidity or you are at risk for the end joints separating.

SUITABLE SUBSTRATES

All substrates listed below must be properly prepared and meet certain requirements. There may be other exceptions and special conditions (as noted below) for these substrates to be suitable for the locking installation system.

- Concrete – dry and smooth on all grade levels and must remain dry year-round.
- Suspended wood sub-floors with approved wood underlayments – must have minimum of 18” well-ventilated crawl space underneath
- Suspended hardwood flooring that is fully adhered, smooth and square edge without texture
- Single-layer, fully-adhered, existing resilient floors – must not be foam-backed or cushion backed
- Ceramic tile, Terrazzo, Marble
- Polymeric Poured (seamless) Floors
- Use Ply-Wood- 3/4 “
- Particleboard 40lb. density or wafer board

DO NOT INSTALL OVER

- Do not install over existing resilient tile floors that are below grade
- Do not install over existing cushion-backed flooring
- Do not install over carpet
- Do not install over hardwood flooring that has been installed directly over concrete
- Do not install over stairs with sloping steps
- Do not install over rooms with sloping floors or floor drains
- Do not install over any other underlayment since the planks already have attached padding

SUCCESSFUL WAYS TO AVOID MOVEMENT OR NOISE

Squeaking and clicking noises can be a result of many causes putting stress on the locking system;

- Locking system not engaged completely on both short and long joints. To avoid this make sure to use a rubber mallet with a tapping block to engage each plank together and test each row. Please note not to use excessive force or the profile will break.
- Do NOT use improper underlayment. (Please contact manufacturer to confirm underlayment).
- If flooring product comes with attached underlayment, you are not allowed to install over foam, rubber underlayment or any other type of padding. Confirm with manufacturer.
- Squeaking noise will not be covered by the warranty and it is the responsibility of installer before they left the job site that they are no noises coming from the entire floor system. The installer should install 100 SF and test the entire floor system integrity and continue to test the floor integrity ever 250SF.
- Joist/sub-floors moving which cause squeaky noises.
- Do NOT use any end joint that are broken (during transit or installation).
- Provide a minimum space based on the thickness of the plank on each wall space for expansion. (Lack of proper expansion space can cause peaking/tenting on the end joints).
- Squeaking noises are not covered by the warranty and note this is a floating floor so noise is allowed. Installers need to check the entire integrity of the floor system before they complete the entire project.
- Confirming that floor is flat before installation. (Sub-floor deflection is not within manufacturer tolerance and the floor is not flat).
- Do NOT install floors in an extreme environment.

In order to minimize squeaking or noise complaints please make sure all points above are met during installation. Squeaking can occur due to the environmental/weather changes.

PRE-INSTALLATION SUBFLOOR REQUIREMENTS

All Sub-floors must be:

- The subfloor must be FLAT, SECURE, and DRY. When installing over any substrate, the use of a moisture barrier vapor is required for protection against future moisture and water from floods and ground swell .6 mil polyfilm (**not over plywood and OSB**) is a suitable moisture barrier which should be overlapped six inches and taped at the seams. Sounds produced between the subfloor and moisture barrier are considered a subfloor issue and are not covered under the product warranty. Subfloors with low and high moisture trapped underneath the flooring can create pressure at the seams resulting in lift, flare, cupping, peaking and separation. It can take several months for the lift, flare, cupping, peaking and separation to become apparent after high moisture in the subfloor exists or flooding occurs, and such conditions are NOT covered under this products warranty.
- Structurally sound
- Clean: Thoroughly swept and free of all debris
- Level: Flat to 4.7mm (3/16”) per 3.3 meters (10-foot) radius
- Dry and remain dry: Subfloor must remain dry year-round. Moisture content of wood sub floors must not exceed 11%, concrete must

not exceed 80% RH (in-situ). For concrete substrates, conduct moisture testing ASTM F1869 (moisture vapor emission rate {MVER}) not to exceed 5lbs. Alternatively, a Tramex test can be performed in accordance with ASTM F2659. However, recorded values higher than 4.5% require a Calcium Chloride test to verify that the subfloor moisture is appropriate.

- For installation on top of concrete subfloors we require a moisture barrier to protect the plank from future moisture and vapor pressure under the flooring. .6 mil polyfilm is a suitable moisture barrier.
- Store the flooring in the installation area for 72 hours before installation to allow flooring to adjust to room temperature. Do not store the boxes of flooring directly on concrete. These floors need adequate acclimation for moisture equalization prior to installation. Shuffle the boards for best visual mix of lengths and color.

ACCLIMATION

As relative humidity varies in different parts of the country, acclimation of the flooring prior to installation is the most important precaution to take in order to ensure a successful installation. Proper acclimation is necessary to adapt the moisture content of the flooring to the conditions of your environment. Improper acclimation can cause the floor to buckle and/or the boards to shrink or cup after installation.

Damage caused by inappropriate handling, environment, installation, or maintenance issues will not be considered in relationship to grade. NOTE: DO NOT OPEN BOXES PRIOR TO INSTALLATION. Boxes to remain completely closed until time of installation.

WOOD SUB-FLOOR

Wood sub-floors must be dry and well secured. Nail or screw every 6" along joists to avoid squeaking. If not level, sand down high spots and fill low spots with a Portland Based leveling patch.

CONCRETE SUB-FLOOR

Concrete sub-floors must be fully cured, at least 60 days old, and should have minimum 6-mil poly-film between concrete and ground. Sub-floor should be flat and level within 3/16" per 10' radius. If necessary grind high spots down and level low spots with a Portland leveling compound. Dry and remain dry: Subfloor must remain dry year-round. Moisture content of wood sub floors must not exceed 11%, concrete must not exceed 80% RH (in-situ). For concrete substrates, conduct moisture testing ASTM F1869 (moisture vapor emission rate {MVER}) not to exceed 5lbs. Alternatively, a Tramex test can be performed in accordance with ASTM F2659. However, recorded values higher than 4.5% require a Calcium Chloride test to verify that the subfloor moisture is appropriate.

A 6 mill poly film moisture retarder is required over the concrete substrate and below the Laminate plank flooring.

Ceramic Tile, resilient tile and sheet laminate must be well-bonded to sub-floor, in good condition, clean and level. Do not sand existing laminate floors, as they may contain asbestos. Laminate flooring should only be installed in temperature-controlled environments. It is necessary to maintain a constant temperature before, during and after the installation. Therefore, the permanent or temporary HVAC system must be in operation before the installation of laminate flooring. Portable heaters are not recommended as they may not heat the room and sub-floor sufficiently. Kerosene heaters should never be used. All substrates must be structurally sound, dry, clean, flat, and smooth with minimal deflection. Substrates must be free from excessive moisture or alkali. Remove dirt, paint, varnish, wax, oils, solvents, other foreign matter and contaminants. High spots on the substrate should be leveled and low areas filled with appropriate underlayments. Do not use products containing petroleum, solvents or citrus oils to prepare substrates as they can cause staining and expansion of the new flooring.

ACCLIMATION

Wood flooring is a hygroscopic material subject to dimensional change as a result of variations in moisture, temperature, and humidity within the surrounding environment. Wood flooring simply needs to reach a moisture content level in equilibrium with the surrounding environment (EMC) IN WHICH IT WILL BE INSTALLED, AT OR NEAR NORMAL LIVING CONDITIONS (Between 40% –55% RH). The process of reaching this equilibrium is defined as acclimation, which allows the wood to properly adjust itself to the normal living conditions within the structure; that is, the temperature, humidity conditions, and moisture content that will typically be experienced once the structure is occupied and stable indoor climate control is exercised.

RENOVATIONS OR REMODEL WORK

For renovation or remodel work, remove any existing adhesive residue so that 100% of the overall area of the original substrate is exposed. Embossed existing resilient floors, ceramic tile floors, ceramic and marble grout joints, and irregularities in concrete should be filled. Maintain temperatures between 55°F (13°C) and 85°F (29°C). For concrete substrates, conduct moisture testing ASTM F1869 (moisture vapor emission rate {MVER}) not to exceed 5lbs and/or percent relative humidity 80% (in-situ probe). Bond tests must also be conducted for compatibility with the substrate.

PLEASE REFER TO SUB-FLOORS AND UNDERLAYMENTS

- Cabinets may be installed over your flooring, but appropriate expansion areas must be maintained around any fixed objects including pipes. Cabinets should be fastened to the walls and not to the flooring. Do not allow screws or nails to penetrate flooring. Under kitchen island you can install our floors but would need to have ¼" gap around the perimeter and cover with a molding/kickboard.

LAMINATE INSTALLATION

- Radiant heated substrates must not exceed a maximum surface temperature of 81°F (27 °C).
- The sub-floor panels must have a smooth, sanded face and show no swelling of edges or surface due to exposure to weather conditions or construction traffic.
- There are numerous products available for use as floor fills, patches, self-leveling underlayments, and trowelable underlayments. They include proprietary blends of compounds such as Portland cement, calcium aluminates, and gypsum based products. These are recommended for smoothing rough or uneven sub-floors, enhancing acoustical and fire characteristics of structures or as substrates to receive floor covering for otherwise unsuitable sub-floor conditions.
- If the flooring is installed over a radiant heat the flooring can experience more movement and cause separation of the planks, cupping, peaking and bowing.

IMPORTANT NOTICE INSTALLATION TOOLS

For all installation methods:

- Tape measure
- Tapping block (Required)
- Pencil
- Leveler
- Rubber Mallet
- 1/2" Spacers
- Pry bar or pull bar
- Chalk line
- Crosscut power saw/ Table Saw (with dust collector)
- 3M Scotch-Blue™ 2080 Tape (do not leave on for more than 12 hours)

Acceptable sub-floor types:

- CDX Underlayment Grade Plywood (at least 1/2" thick) Underlayment grade particleboard (at least 3/4" thick)
- Concrete slab
- Existing wood floor
- Ceramic tile, Resilient tile & sheet laminate

STARTING YOUR INSTALLATION

Work from several open boxes of flooring and “dry lay” the floor before permanently laying the floor. This will allow you to select the varying grains & colors and to arrange them in a harmonious pattern. Remember, it is the installer’s responsibility to determine the expectations of what the finished floor will look like with the end user first and then to cull out pieces that do not meet those expectations. Begin installation next to an outside wall. This is usually the straightest and best reference for establishing a straight working line. Establish this line by measuring an equal distance from the wall at both ends and snapping a chalk line. The distance you measure from the wall should be the width of a plank. You may need to scribe cut the first row of planks to match the wall in order to make a straight working line if the wall is out of straight.

You may want to position a few rows before starting installation to confirm your layout decision and working line. When laying flooring, stagger end joints from row to row by at least 8". When cutting the last plank in a row to fit, you can use the cut-off end to begin the next row. If cut-off end is 8" in length or less, discard it and instead cut a new plank at a random length and use it to start the next row. Always begin each row from the same side of the room. When near a wall, you can use a pry bar to pry close the side and end joints.

RECOMMENDED - FLOATING INSTALLATION

For Floating installation, the planks are not to be secured to the subfloor. Always undercut wood door jambs. Avoid “pinch points” on any fixed home materials with an expansion gap the thickness of the floor. LAYOUT – It is important to balance the layout of the plank format. Proper planning and layout will prevent narrow plank widths at walls. Determine layout to prevent having less than half a plank width or very short pieces. As with all plank products, lay the long dimension of the plank parallel to the long dimension of the work area. Accurately measure the room to determine the centerline, adjust this established line to accommodate a balanced layout and then transpose this line to a comfortable width away from the starting wall (approximately 2' to 3' wide). Determine if the starter row will need to be cut. If the first row of planks does not need to be trimmed in width, it may be necessary to cut off the unsupported tongue so a clean, solid edge is toward the wall.

ALL AREAS INSTALLATION

Cleaning and Underlay: After thoroughly cleaning the subfloor, you should install a foam underlay (unless your product has a pre-attached pad). Run the foam underlay in the same direction as the flooring planks. The underlay should be butted side-by-side with no overlap. Tape seams together. If you are installing over a concrete subfloor, a 6-mil poly (plastic sheeting) is recommended to be installed under the foam underlay. (Many foam underlays already have this plastic sheeting pre-attached).

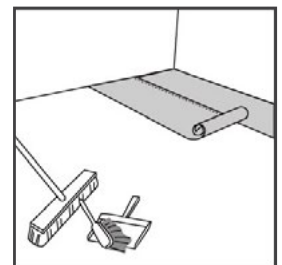

TWO DIFFERENT WAYS TO INSTALL THE PLANKS

Method 1: Angle-In Installation Method (7.7" Wide Planks or Less)

Position the panel to be installed at an angle of 20°-30° to the panel already installed. Move the panel gently up and down and at the same time exert forward pressure. The panels will automatically click into place. You can either insert the tongue into the groove, or the groove onto the tongue. The tongue in groove method is the most common and the easiest way.

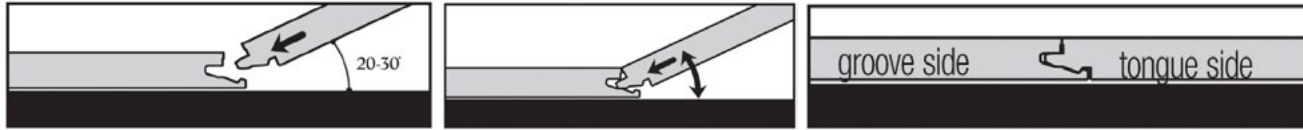

Method 2: Flat installation Method (9" Wide Planks or Greater)

You can also tap the panels into each other without lifting. For this method you must use the special tapping block. The planks should not be joined with a single tap and the tapping block should set flat on the floor. To avoid damaging the panels you must tap them together gradually. See diagram 2 a-b. Use this method only in cases where you are unable to use the Angle-In method (see below). The rest of your floor should be installed using the Angle In method.

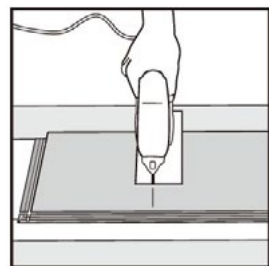
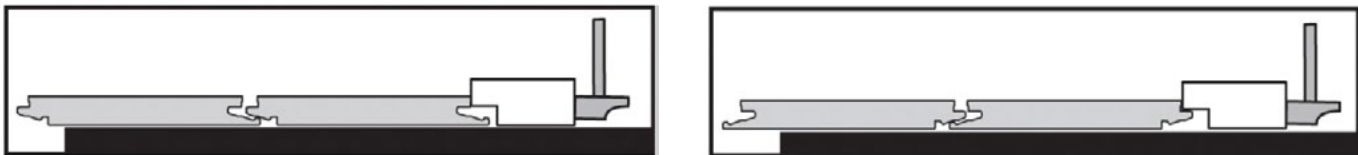

Cutting the Plank

If cutting with a jig saw, the laminate surface should be turned down. If cutting with a hand saw, the laminate surface should be face up.

Planning Your Layout

It is very important to plan your layout to avoid an unbalanced appearance. Lay the long dimension of the planks parallel to the longest wall. Lay a chalk line lengthwise along the middle of the room. Do a dry layout of planks from the direction of the planks to determine the width of the last row of planks see the diagram to the right.

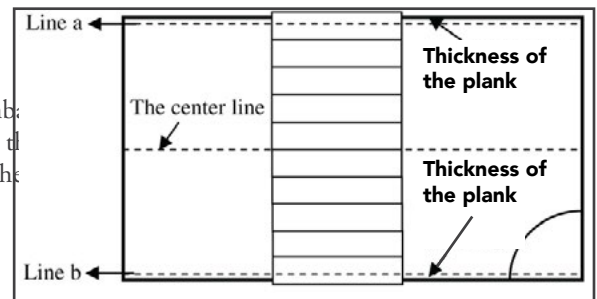

- Reserve an expansion gap the thickness of the plank. Avoid having less than a half plank width at the line and / or line.
- Measure the width of the room at the front, middle and back and divide the widths of each measurement by the width of a plank. If the remainder is less than half the plank width, then the planks on your starter row should be narrowed to make the last row approximately half the plank. The width of the last row of planks should be approximately the same width as the first row of planks.

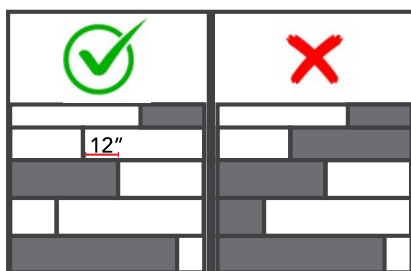

Note: This may also be figured out by laying down loose planks across the width of the room without securing them to each other and making the necessary adjustments.

During installation, make sure that you mix the floor panels (and floor boxes) sufficiently so that there are not too many identical, lighter or darker planks next to each other. To obtain the best visual effect, it is best to install the panels in the direction of the longest wall and/or parallel to the incidence of light. Ensure that the end joints of the panels in 2 successive rows are never in line, they should be staggered by at least 12 inches. For a natural look and better mechanical strength, we do not recommend an installation of the planks in a pattern but rather at random formation.

LAMINATE INSTALLATION

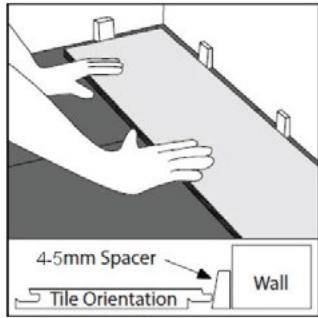

Step 1
Laying first plank in corner of room with tongue side facing wall using the thickness of the plank space size

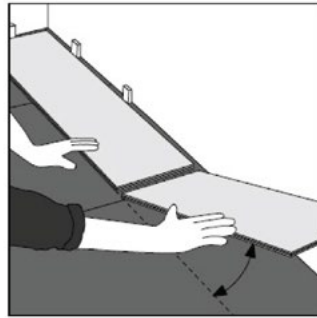

Step 2
Fitting of second plank

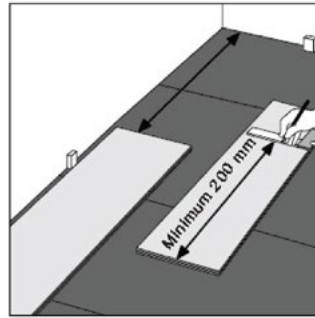

Step 3
Cutting and fitting of final plank in first row

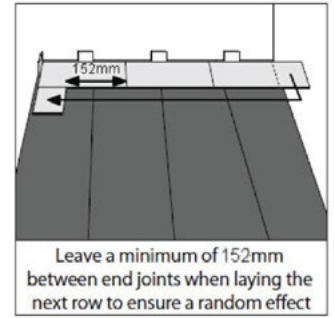

Step 4
Use of offcut from previous row (optional)
Leave a minimum of 152mm between end joints when laying the next row to ensure a random effect

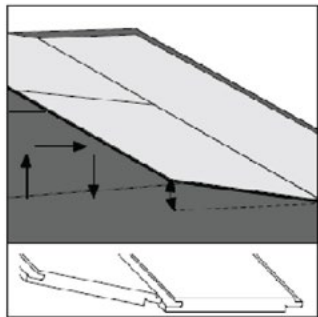

Step 5
Fitting of additional planks in second row

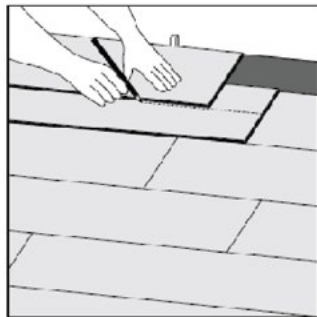

Step 6
Measure and cut final row of planks allowing for an expansion gap the thickness of the plank

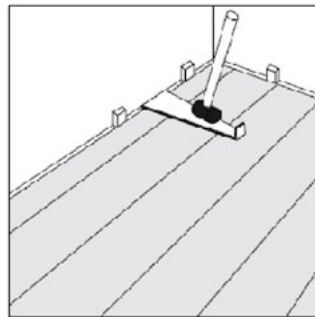

Step 7
Pull bar and rubber mallet can be used for final row of planks, ensuring an expansion gap is the thickness of the plank

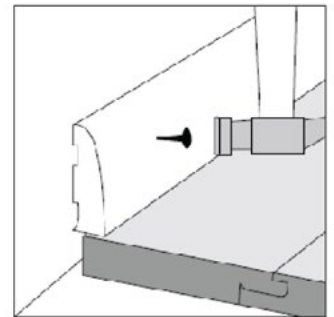

Step 8
Refitting of skirting board with hidden an expansion gap is the thickness of the plank

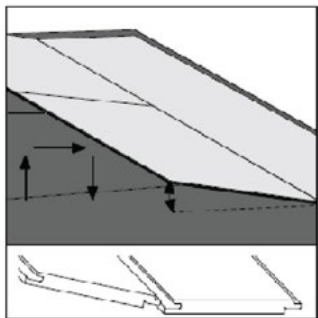

Step 9
Fixing edge trim to wall

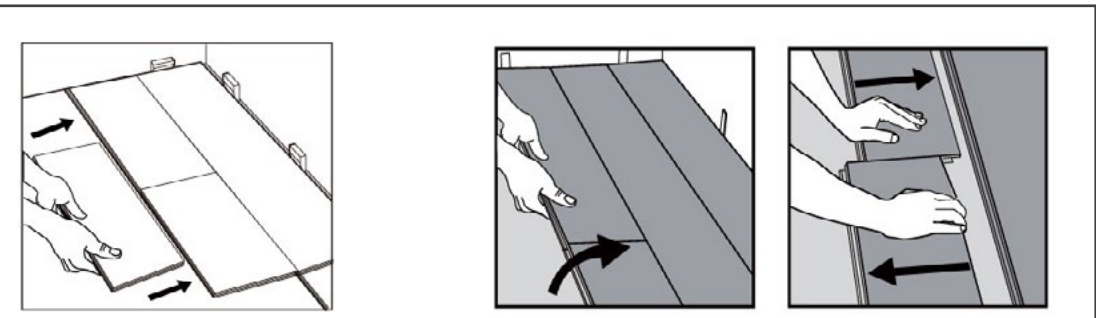

HELPFUL HINT

When installing each new row, take a full loose plank and use the long side to tap against the prior row to ensure no gapping.

DISASSEMBLING

Separate the whole row by lifting it up delicately at an angle. To separate the planks, leave them flat on the ground and slide them apart.

INSTALLATION IN WET AREAS (I.E. BATHROOM, KITCHEN, MUD ROOM, LAUNDRY ROOM)

Since prolonged water exposure could damage your laminate flooring, the following installation recommendations should be closely followed to validate your residential water warranty. Wet areas would include, but are not limited to: bathrooms, powder rooms, kitchens, mud rooms, foyers, and laundry rooms. Neither flooring planks nor accessories are recommended for applications with extreme low or high humidity. The water warranty excludes all products thinner than 3/8". An expansion area of the thickness of the plank must be provided around all vertical obstructions including walls, permanent cabinets, pipes, etc. All perimeter expansion areas must be completely filled in with a water-repellent flexible silicone sealant. When applying sealant, it is helpful to first apply a strip of masking tape parallel to and approximately 1/32-inch from the edge of the flooring. Then fill the expansion area with sealant, remove any excess with a plastic scraper or putty knife, then remove the tape. Let dry for 24 hours before exposure to water. It is important that moisture does not enter the core of any cut planks.

WET AREA RECOMMENDATIONS

Special procedures should be followed when installing laminate floors in areas that are prone to moisture (i.e. bathrooms, powder rooms, kitchens, mud rooms, foyers, and laundry rooms).

- Always install an 6mil (0.15mm) vapor barrier prior to installing the underlay and laminate flooring.
 - Overlap vapor barrier edges by 8" (20cm) and seal with moisture resistant adhesive tape.
 - Run vapor barrier 3/4" (2cm) up wall and trim after wall base is installed.
- Fill all expansion spaces with 100% silicone caulking (caulking is flexible and will still allow laminate floors to expand and contract).
- The toilet must be removed when installing laminate floors in bathrooms and an expansion the thickness of the plank must be left between the flooring edge and the toilet flange. The expansion space must be filled with 100% silicon caulking.

Laminate flooring is made from wood and excessive exposure to moisture will damage the planks. It is strongly recommended that spills be wiped up immediately.

PIPES

In rows where there is a pipe, make sure the pipe falls exactly in line with the short side of two planks. Take a drill bit with the same diameter as the pipe plus 3/4-inch for the expansion. Click the planks together on the short side and drill a hole centered on the joint between the two planks. Now you can install the planks in the floor. See Diagrams 6A-6B-6C.

UNDER DOOR FRAMES

When sawing the planks, ensure that the expansion joint under the door is at least the thickness of the plank. If you cannot lift the plank, use an adapted tapping block or pull bar and hammer to tap the planks together with the planks flat on the floor.

FINISHING

Remove all spacers. Install the molding on the plastic membrane that runs up the wall from under the floor. Never attach the molding to the floor. This method allows the floor to expand and contract under the molding.

- For a perfect finish around pipes, use rosettes or flexible silicone sealant.
- In places where profiles or moldings cannot be placed, fill expansion gaps with flexible silicone sealant

REPLACEMENT

Disassembling Panels Near Walls

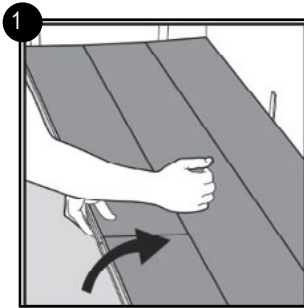

Separate the whole row by carefully lifting up and release the whole row.

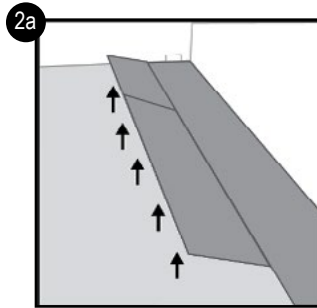

Disassemble the panels by lifting the short ends upward and disengage from the rest.

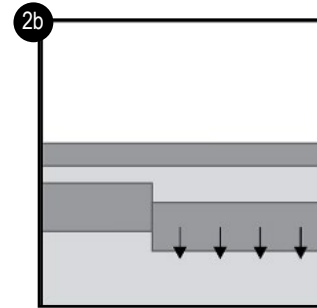

Slide one panel forward. Never fold up a panel, as this damage the profile.

How NOT to Disassemble a Panel

DO NOT lift planks from the center. This will cause damage the groove. Please use the slide method or lift planks from the end joint as shown on the step above.

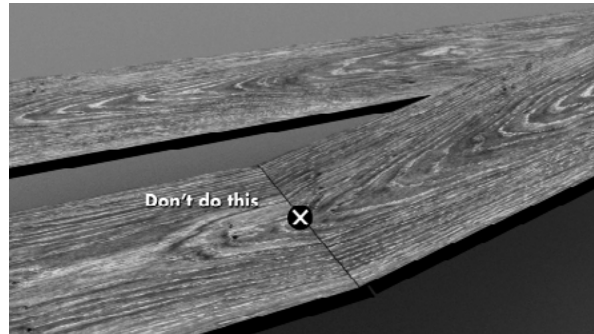

Replacement of a Panel in the Middle of the Room

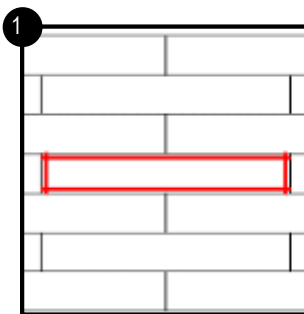

Please cut the panel along the red lines as indicated below.

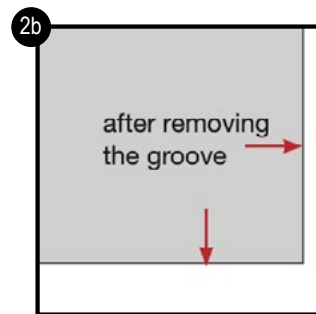
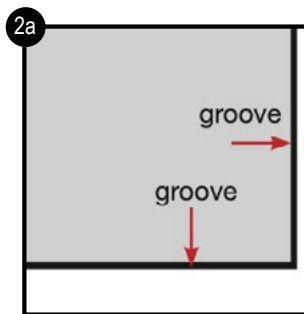

Remove the groove on both sides as indicated in the above pictures.

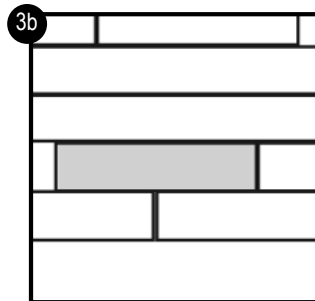
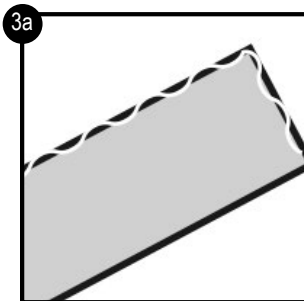

Apply glue on the cut groove side to adhere to the adjacent planks. When replacing planks the new plank will look different from the existing plank by the bevel size, texture, color, size and gloss level. There is color varies from batch to batch.